

Kit 1581

RENAULT Mégane, 3-dr Coupé, 09-

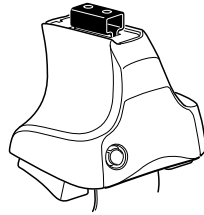

480R
754

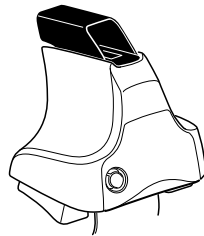
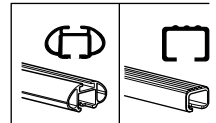

480

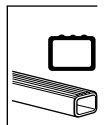

1

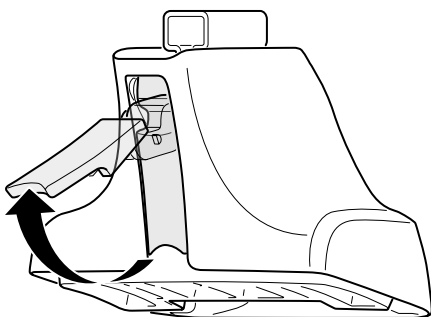
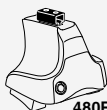

2



+

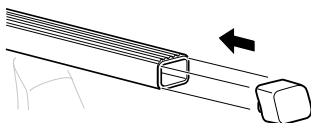
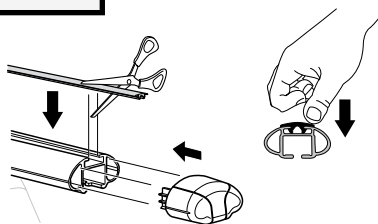
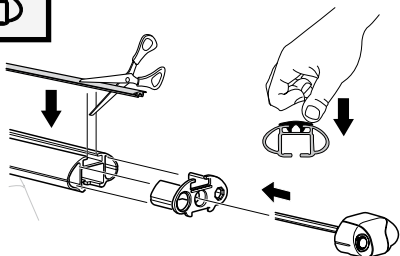
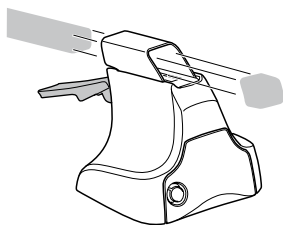
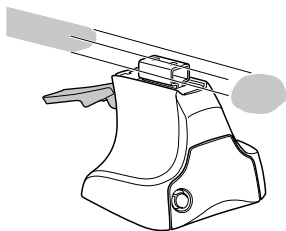

3

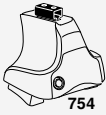

754

1

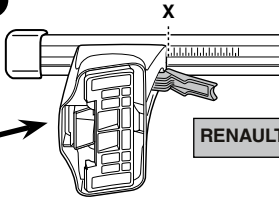
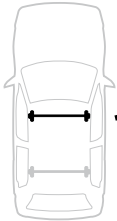

2

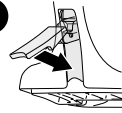

RENAULT Mégane, 3-dr Coupé, 09–

X

37,5

1

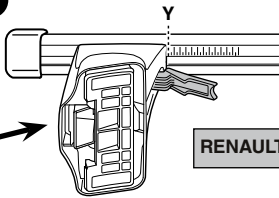

2

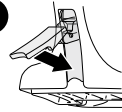

RENAULT Mégane, 3-dr Coupé, 09–

Y

34,5



480R

480

1

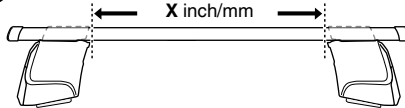

2

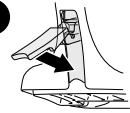

RENAULT Mégane, 3-dr Coupé, 09–

X inch

X mm

40 ³/₈"

1026 mm

1

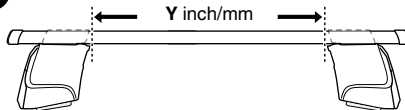

2

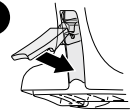

RENAULT Mégane, 3-dr Coupé, 09–

Y inch

Y mm

39 ¹/₄"

996 mm

4

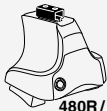

480R/754



480

RENAULT Mégane, 3-dr Coupé, 09-

251



926

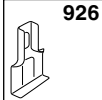

FL



252



926

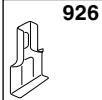

FR



328



1059

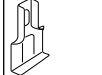

RL



328



1059

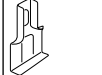

RR

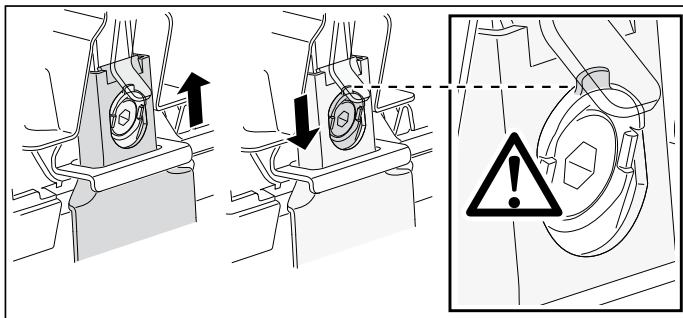
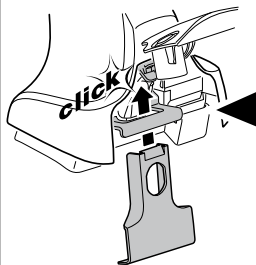
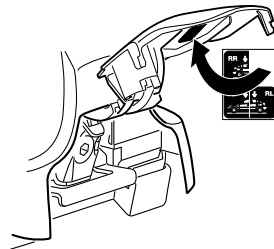
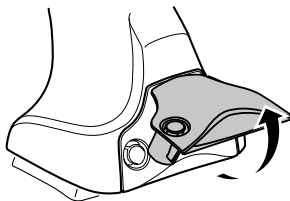
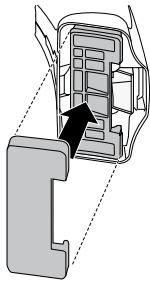

5



	X mm	Y mm	X inch	Y inch
RENAULT Mégane, 3-dr Coupé, 09-	165 mm	700 mm	6 1/2"	27 1/2"

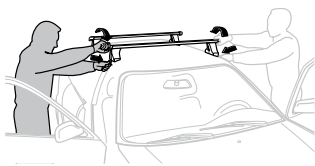
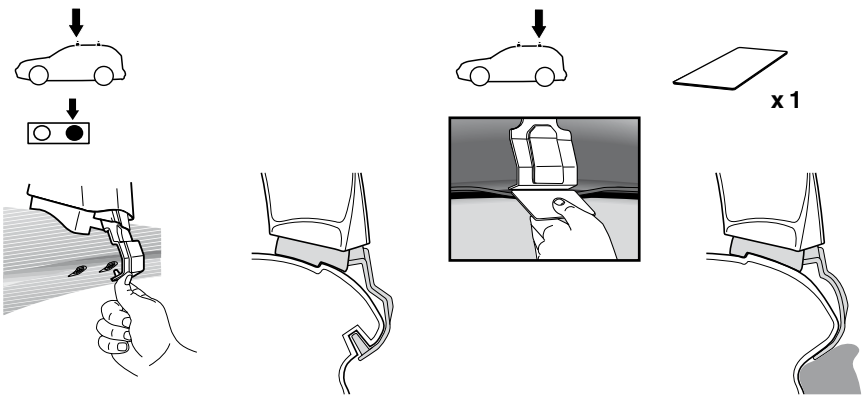
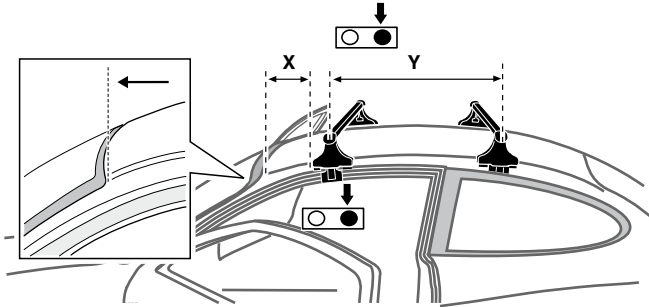

- | | | | |
|--------------|---|------------|---|
| GB/US | Tighten alternately | CZ | Pokřetla bagazníka dokřečaj dokřečaj napřezmiennie. |
| D | Die Schrauben abwechselnd anziehen | SK | Dofahujte striedavo |
| F | Serrer alternativement chaque côté | SLO | Privijajte izmenično. |
| NL | Afwisselend aan de linker- en de rechterkant aandraaien | HR | Naizmjenično zategnite |
| I | Alternare il serraggio delle viti | HU | Egymástól függetlenül szorítandó |
| E | Apretar alternativamente | GR | Σφιγγετε εναλλάξ |
| PT | Aperte alternadamente | TR | Dönüşümlü sıkın |
| S | Dra åt växelvis | 中文 | 交替拧紧 |
| FIN | Kierrä vuorotellen | 한국어 | 번갈아 가며 조이십시오. |
| EST | Pinguldage vaheldumisi | 日本語 | 交互に締め付けてください。 |
| LAT | Pievēlciēt pamišus | ไทย | ขันในแบบสลับ |
| LIT | Užsukinėkite pakaitomis | | |
| PL | Śruby dokręcaj naprzemiennie | | |
| RU | Затягивайте попеременно | | |

6

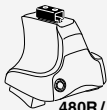

480R/754



480

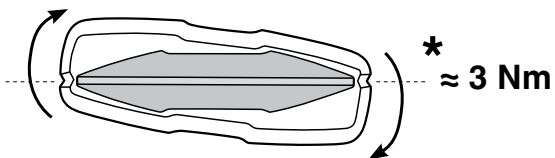
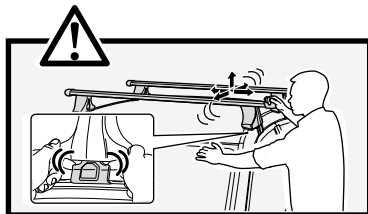
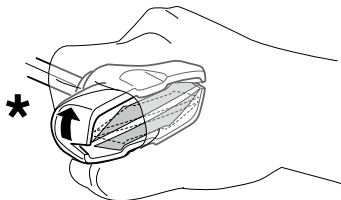
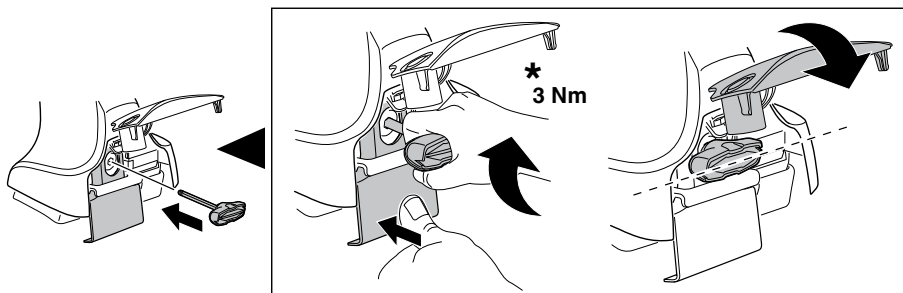

7

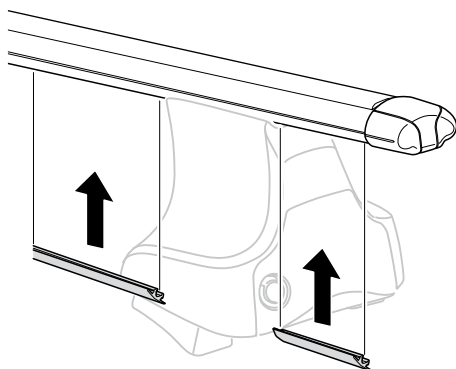
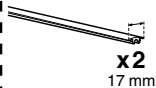

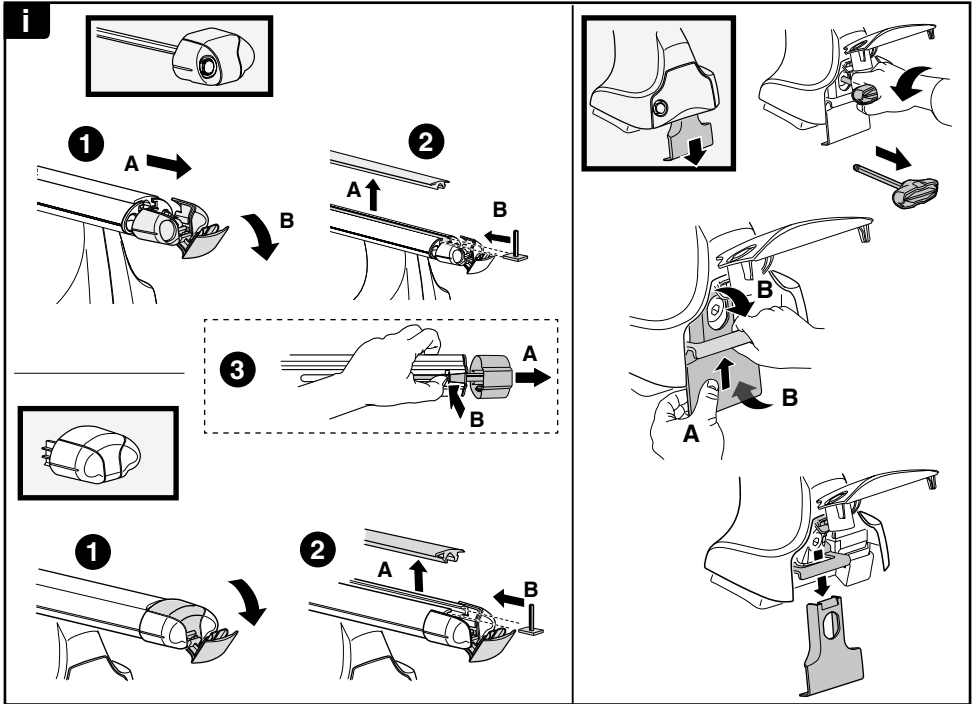
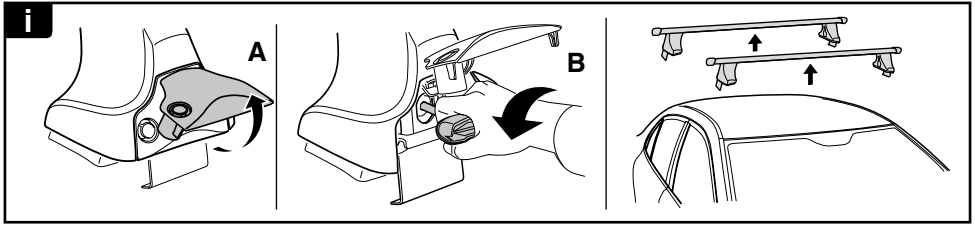

THULE
SWEDEN

**ONE
KEY
SYSTEM**

- 544 (x4)
- 596 (x6)
- 588 (x8)
- NA 510 (x10)
- EUR 452 (x12)
- ASIA